

NATIONAL TIME has simplified the wireless clock system with the TimeCast™ family of clock products. This wireless technology utilizes license-free frequency bands to communicate synchronized time to all of the clocks in your building. A cost-effective base station is the heart of the system keeping accurate time using a local or internet SNTP time server. Time and other data is broadcast from the base station to nearby clocks using a low wattage transmitter. Each clock in the system is capable of relaying this data to more distant clocks. A flood of time information synchronizes the time throughout your facility in fractions of a second. This efficient two-way data transmission provides verification of time synchronization, battery level, signal strength, and other clock information. All of this information is available to the user via National Time's free cloud service. Reports of clock system health can be accessed through the internet or by scheduled e-mail messages.

Installation of the system is simplified with National's exclusive interactive display on the back of each TimeCast™ clock. The display provides a user friendly interface to simplify installation as well as providing status information such as signal strength, battery strength, number of other clocks in range, time and date received, check in times, and firmware information. Help screens aid in fixing problems eliminating tech support and service calls. In the absence of a base station, the time and date can be entered by the user or acquire time from a nearby clock. This allows installation of the clocks if the network infrastructure for the base station is not yet installed.

Fast, Easy Setup -National's *Exclusive* multi-line display for user-friendly, step-by-step help and diagnosis.

Free Cloud Monitoring -National Time's free cloud service monitors each clock's vitals and check-in history. Get notified of low batteries or synchronization failure *before* it becomes a problem.

Robust Communication -Multiple path Flooding TimeCast™ technique is simple and reliable for trouble-free data transmission.

License Free -Using low energy and ISM frequency bands does not require a site license application or fee.

Support -Proudly designed, manufactured, and supported in Michigan USA.



TimeCast™ Base Station



A cost-effective base station is the beginning of your TimeCast™ system. This Power-over-Ethernet (POE) unit is small enough to mount wherever needed. For installations without POE, the unit can be powered with a 5VDC micro USB wall plug. The easy to understand user interface with 4-line display makes set-up a breeze. The LAN connection can use a local or internet SNTP time server to keep accurate time. A battery-less backup system can keep time during outages for over 10 days. TimeCast™ signals are transmitted to all nearby clocks and is repeated by each clock for complete building coverage. All secondary clock information is gathered by the base station and stored locally or uploaded to the free National Time cloud service.

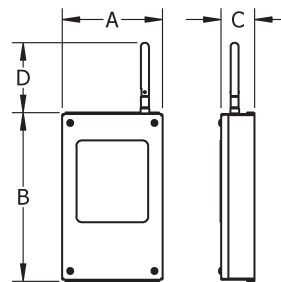

Dimensions	
A	4.62"
B	7.75"
C	1.54"
D	3.20"

Model Number	Description
TC-BS-WM	TimeCast Base Station, POE; Wall Mount
WT-5V-MU	120/5VDC 1A Plug-in Wall Transformer, Micro USB

TimeCast™ Operation

Each clock repeats TimeCast™ signals to more distant clocks creating a "Flood" of data lasting only a fraction of a second.

120V and 24V powered analog and digital clocks as well as battery powered analog clocks are available.

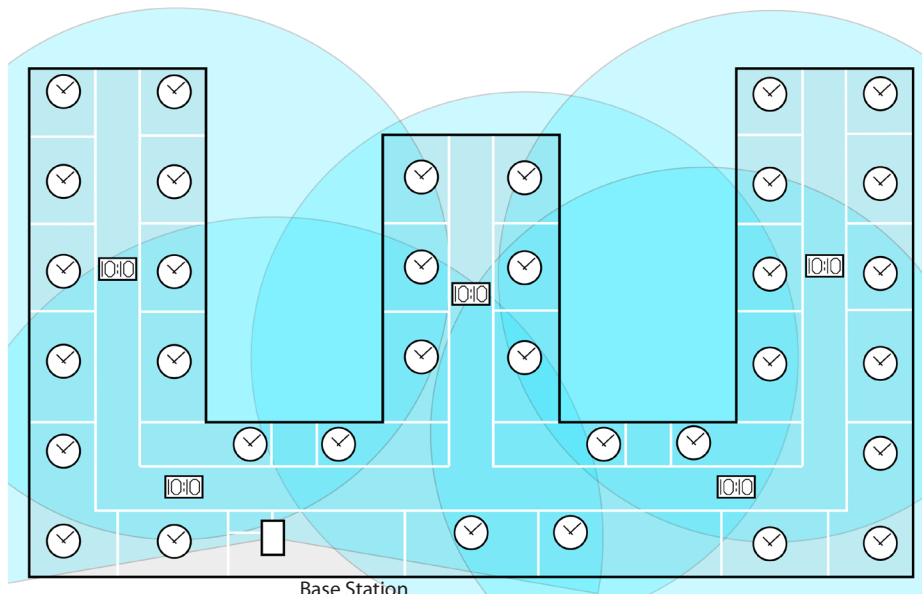

Wired clocks function as remote base stations. This makes installation and battery changes to the non-wired clocks effortless.

National Time Cloud

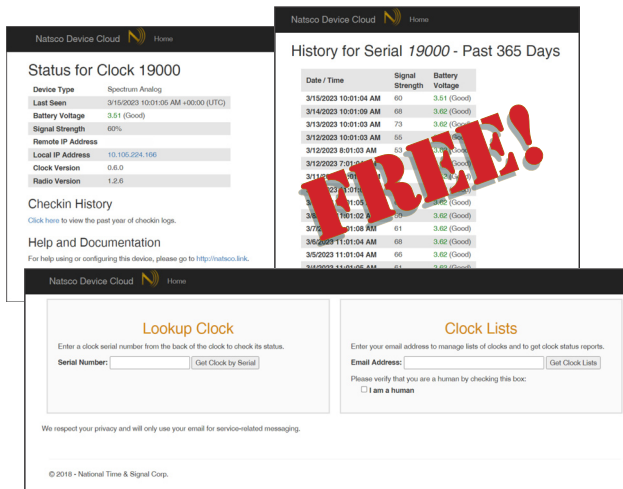

The National Time Device Cloud is a free service available to all customers. This browser based interface works on all devices without any software to install or manage. The cloud service can be used for National Time's Wifi and TimeCast™ series of devices. View information about the clocks such as firmware version, battery voltage and signal strength. Even historical data is available to help diagnose past problems. Custom lists can be created to view the status of multiple clocks and reports can be scheduled to send by email.

TimeCast™ Clock User Interface

Industry first and only OLED display at each clock provides easy setup and diagnosis. Quickly determine if TimeCast™ signal and time data has been received. At a glance, determine the signal strength from the clock back to the base station, battery voltage, number of peer clocks within range and other information.

User buttons provide menu navigation and setting initial time and date if necessary.

Unique QR code at each clock directly links to the free NATSCO cloud service. Complete check-in history with signal and battery strength is displayed as well as product information and trouble shooting assistance.

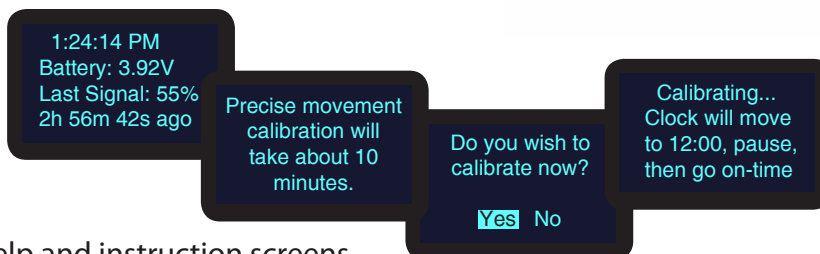

Easy to understand help and instruction screens.

TimeCast™ Analog Secondary Clocks



The TimeCast™ analog battery powered analog clocks make clock system expansion simple. Hang wherever a clock is desired without the need for additional system wiring. These energy efficient clocks have a life expectancy of 2.5 years on (3) AA batteries and 5 years with the six battery option.

When battery maintenance is not desired, order the 24V wired version. The 24V version can be powered with 24VAC or 24VDC. These can leverage easier to install low voltage power-limited wiring for less costly installation. For line voltage 120V installations, there is a

choice of a hard wired transformer that fits in a standard electrical box or a wall transformer that plugs into a nearby standard outlet. Double face clocks can share a single transformer. All versions include National Time's exclusive user display interface to simplify installation and troubleshooting. The clock cases come in two sizes: 12" and 16". The 12" clock cases have durable ABS case with shatterproof polycarbonate lens while the 16" clock cases have steel case with shatterproof lens. Double face clocks have a sturdy steel mounting ring and bracket. Cases are available in black or grey. The dials are standard white with black numerals and markers. Contact the factory for custom dials and logos for your school or business.

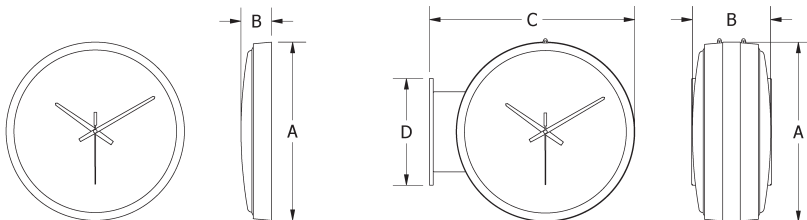

Dial Size	A	B	C	D
Single Face 12" Round	13.35"	2.28"	--	--
Double Face 12" Round	13.44"	5.88"	15.44"	8.00"
Single Face LR 16" Round	17.0"	2.50"	--	--

Single Face Mounting:

12": Single screw or Anti-sway bracket
16": Anti-sway bracket

Double Face Mounting:

Securely Mounted 4" Square Deep Electrical box. Battery/WT powered version do not require electrical box for mounting.

Mounting Options

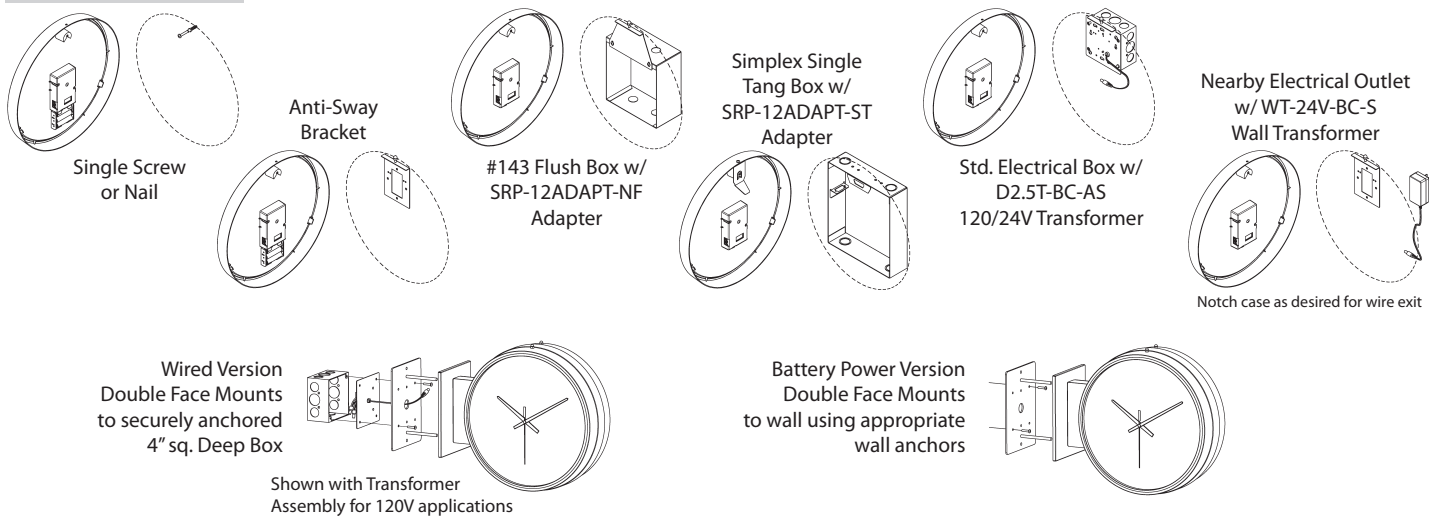

Specifications

Indoor Use Only

Frequency: 2.4GHz ISM band; <1 Watt

Power: **3B/6B:** 3 or 6 AA Alkaline Batteries

24V: 27mA@24VAC (16-28VAC); 17mA@24VDC (15-35VDC)

120V Hard wired: 20mA@120VAC (108-132VAC)

120V Wall transformer: 15mA@120VAC (100-240VAC)

Ordering Information

Full Clock Assemblies

Model Number	Description
12" Analog Clocks - Single Face	
SRP-12TC-3B	Surface Round ABS/PC 12" TimeCast Clock, (3)AA Battery
SRP-12TC-6B	Surface Round ABS/PC 12" TimeCast Clock, (6)AA Battery
SRP-12TC-24V	Surface Round ABS/PC 12" TimeCast Clock, 24VAC/DC
SRP-12TC-120V-HW	Surface Round ABS/PC 12" TimeCast Clock, 120V w/ Hard-wired Transformer
12" Analog Clocks - Double Face	
DRP-12TC-3B	Double Face Round ABS/PC/Steel 12" TimeCast Clock, (3)AA Battery
DRP-12TC-6B	Double Face Round ABS/PC/Steel 12" TimeCast Clock, (6)AA Battery
DRP-12TC-24V	Double Face Round ABS/PC/Steel 12" TimeCast Clock, 24VAC/DC
DRP-12TC-120V-HW	Double Face Round ABS/PC/Steel 12" TimeCast Clock, 120V w/ Hard-wired Transformer
DRP-12TC-120V-WT	Double Face Round ABS/PC/Steel 12" TimeCast Clock, 120V w/ Plug-in Wall Transformer
16" Analog Clocks - Single Face, Low Profile	
LR-16TC-3B	Low Profile Round Steel 16" TimeCast Clock, (3)AA Battery
LR-16TC-6B	Low Profile Round Steel 16" TimeCast Clock, (6)AA Battery
LR-16TC-24V	Low Profile Round Steel 16" TimeCast Clock, 24VAC/DC
LR-16TC-120V-HW	Low Profile Round Steel 16" TimeCast Clock, 120V w/ Hard-wired Transformer
LR-16TC-120V-WT	Low Profile Round Steel 16" TimeCast Clock, 120V w/ Plug-in Wall Transformer

Default Color is Grey. Add Suffix -BLK to part numbers for Black enclosures

Accessories



Anti-Sway Bracket
(Included)



SRP-12ADAPT-ST



SRP-12ADAPT-NF



D2.5T-BC-AS



WT-24V-BC-S
(6' cord)



D5T-BC-AD

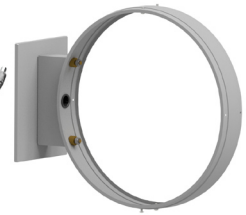

SRP-12-CORR KIT

Model Number	Description
Double Face Corridor Kits (Included with Double Face Clock Assemblies)	
SRP-12-CORR KIT	Corridor Kit for SRP 12" Clocks
Transformer Assemblies for Analog Clocks (Included with 120V Clock Assemblies)	
D2.5T-BC-AS	120/20V 2.5W Hard Wired Transfmr w/ Barrel connector for Analog Single Face Clocks
D5T-BC-AD	120/20V 5W Hard Wired Transfmr w/ Barrel Connectors for Analog Double Face Clocks
WT-24V-BC-S	120/24VDC 0.5A Plug-in Wall Transformer, Barrel connector
WT-24V-BC-D	120/24VDC 0.5A Plug-in Wall Transformer, Two Barrel connectors
Accessories	
SRP-12ADAPT-NF	Adapter bracket for National #143 flush clock back box
SRP-12ADAPT-ST	Adapter bracket for Simplex Style single-tang mounting to flush back box

TimeCast™ Digital Secondary Clocks



The TimeCast™ digital clock series has more features that benefit your organization than any other. NATSCO's exclusive automatic dim feature decreases the brightness to compensate for low ambient light levels associated with surgical suites and video productions. This not



only provides a pleasant brightness level, but also saves energy during nighttime hours. Nine brightness levels may be selected to satisfy the brightest locations. Add a durable metal housing to the long life epoxy filled digit segments and you won't find better value. Available in both 2.3" and 4" wide bar digits that increase the visibility over clocks of comparable size. 6-Digit versions displaying hours, minutes and seconds are also available. The 24VAC/DC version can leverage easier to install, low voltage, power-limited wiring for less costly installation. The 120V version can use a local 120V circuit. The hard wired version includes a 120/24V transformer that mounts in a standard electrical box. The wall transformer version can plug into a nearby standard 120V outlet. Cases are available in black or grey.

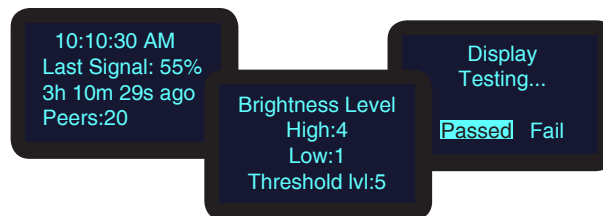
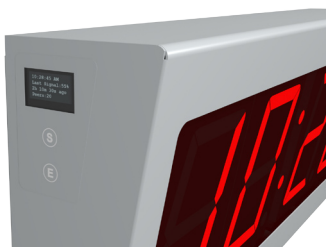

The OLED display behind each clock provides easy setup and diagnosis. Quickly determine if the TimeCast™ signal and time data has been received. At a glance, determine the signal strength from the clock back to the base station, last check-in, number of peer clocks within range and other information. User buttons provide menu navigation and setting initial time and date if necessary. Clock settings such as brightness, auto-dim thresholds, time zone and test routines also utilize this easy to understand display. Unique QR code at each clock directly links to the free NATSCO cloud service. Complete check-in history with signal strength and nearby clock information is displayed as well as product information and trouble shooting assistance.



Specifications

Indoor Use Only
Frequency: 2.4GHz ISM band; <1 Watt

units mA	24VDC		24VAC		WT 120V		HW 120V	
	Typ.	Max.	Typ.	Max.	Typ.	Max.	Typ.	Max.
Part No.								
SF-DTC225-4	24	34	41	58	20	27	17	18
SF-DTC225-6	37	60	58	90	27	49	18	23
DF-DTC225-4	36	59	60	93	25	37	17	21
DF-DTC225-6	56	108	84	152	38	59	28	38

units mA	24VDC		24VAC		WT 120V		HW 120V	
	Typ.	Max.	Typ.	Max.	Typ.	Max.	Typ.	Max.
Part No.								
SF-DTC400-4	52	65	71	102	25	28	29	40
SF-DTC400-6	52	82	77	124	26	33	34	50
DF-DTC400-4	60	106	98	160	28	37	39	57
DF-DTC400-6	77	150	122	212	33	49	47	78

Typical current for brightness setting=4; Maximum current for brightness setting=9

Mounting Options

Hard-wired Installations

The DTC225 and DTC400 are natively 24V AC/DC powered. They can connect directly to a shared centralized 24V power source such as a NATSCO PS-3 Power Supply.

For 120VAC installations, the appropriate hard-wired transformer provides 24VAC. The mounting plate screws to a deep 4" square electrical box.

For surface conduit installations, order the appropriate D225/400 Surface Box. The surface box provides a conduit entry on the long or short sides.

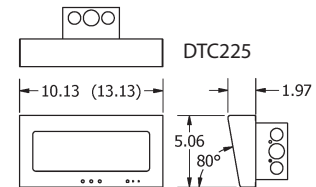
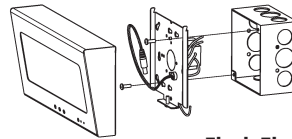
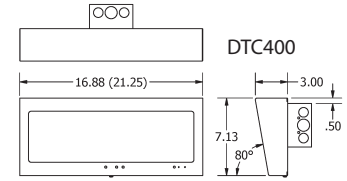
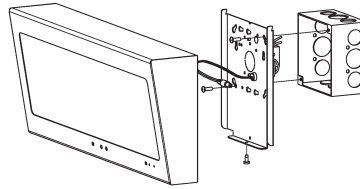

Flush Electrical Box
(Shown with Transformers)

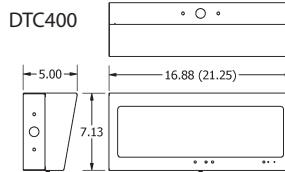
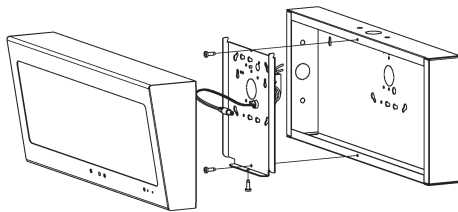

Surface Mounted Box

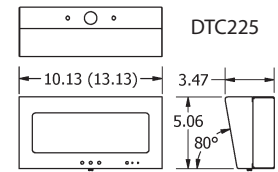
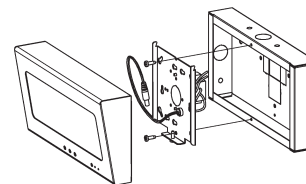

Double Face Hard wired Installations

A DTC225 or DTC400 clock and a secondary display mounts to a **Corridor Kit** to create a double sided clock that can be wall or ceiling mounted. They mount to a securely installed deep 4" square electrical box. For 120V installations, the D5T-D225-BC-DBL or D5T-D400-BC-DBL transformer that is attached to a mounting plate positioning the transformer inside the electrical box.

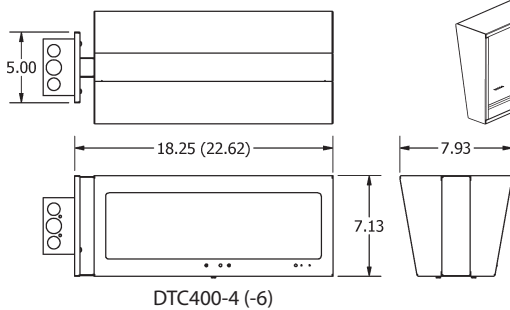

Wall Mounted

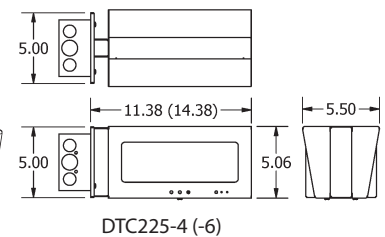

D400 Corridor Surface Box

Surface Conduit Installation

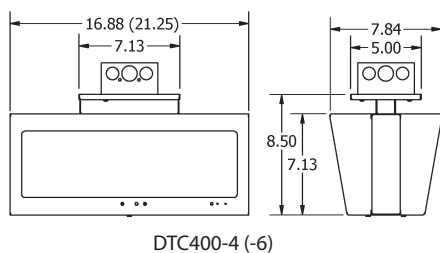

Ceiling Mounted

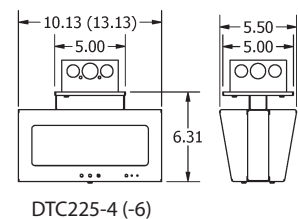

Wall Transformer Installation

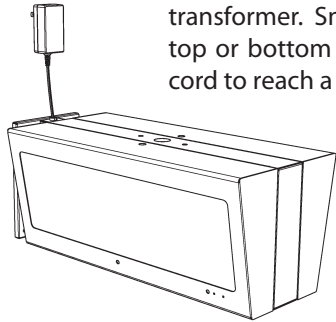

The DTC225 and DTC400 models can be powered by a plug-in wall transformer. Small knockouts for a wire strain relief can be used at the top or bottom of the clock enclosure. The wall transformer has a 6' cord to reach a nearby 120VAC outlet.

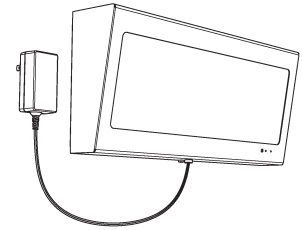

The double face assembly provides a knock out on the wall bracket spacer for cable entry from the top or the bottom.

Mounting Plates and Accessories



D225 (Std)



D2.5T-D225-BC

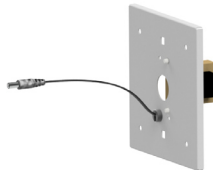

D5T-D225-BC-DBL



D400 (Std)



D5T-D400-BC



D5T-D400-BC-DBL

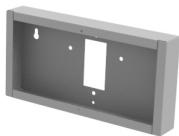

D225-4 Surface Box

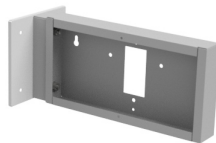

D225-4 Corridor Kit

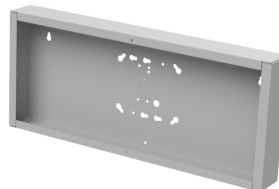

D400-4 Surface Box

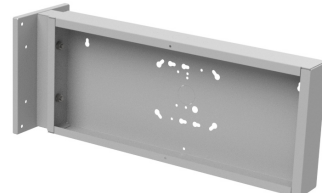

D400-4 Corridor Kit



D400-CORR-SURF-BOX

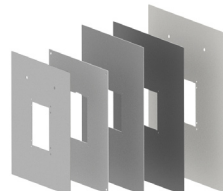

Adapter Plates for existing Boxes



Clear-View Guard

Full Digital Clock Assemblies

Model Number	Description
2.3" Digital Clocks - Single Face	
SF-DTC225-4-24V	TimeCast 2.3" Digital Clock, 4-Digit, 24V
SF-DTC225-4-120V-HW	TimeCast 2.3" Digital Clock, 4-Digit, w/120V Hard-Wired Transformer
SF-DTC225-4-120V-WT	TimeCast 2.3" Digital Clock, 4-Digit, w/120V Wall Transformer-Grey
SF-DTC225-6-24V	TimeCast 2.3" Digital Clock, 6-Digit, 24V
SF-DTC225-6-120V-HW	TimeCast 2.3" Digital Clock, 6-Digit, w/120V Hard-Wired Transformer
SF-DTC225-6-120V-WT	TimeCast 2.3" Digital Clock, 6-Digit, w/120V Wall Transformer
2.3" Digital Clocks - Double Face¹	
DF-DTC225-4-24V	TimeCast 2.3" Double Face Digital Clock, 4-Digit, 24V
DF-DTC225-4-120V-HW	TimeCast 2.3" Double Face Digital Clock, 4-Digit, w/120V Hard-Wired Transformer
DF-DTC225-4-120V-WT	TimeCast 2.3" Double Face Digital Clock, 4-Digit, w/120V Wall Transformer
DF-DTC225-6-24V	TimeCast 2.3" Double Face Digital Clock, 6-Digit, 24V
DF-DTC225-6-120V-HW	TimeCast 2.3" Double Face Digital Clock, 6-Digit, w/120V Hard-Wired Transformer
DF-DTC225-6-120V-WT	TimeCast 2.3" Double Face Digital Clock, 6-Digit, w/120V Wall Transformer
4" Digital Clocks - Single Face	
SF-DTC400-4-24V	TimeCast 4" Digital Clock, 4-Digit, 24V
SF-DTC400-4-120V-HW	TimeCast 4" Digital Clock, 4-Digit, w/120V Hard-Wired Transformer
SF-DTC400-4-120V-WT	TimeCast 4" Digital Clock, 4-Digit, w/120V Wall Transformer
SF-DTC400-6-24V	TimeCast 4" Digital Clock, 6-Digit, 24V
SF-DTC400-6-120V-HW	TimeCast 4" Digital Clock, 6-Digit, w/120V Hard-Wired Transformer
SF-DTC400-6-120V-WT	TimeCast 4" Digital Clock, 6-Digit, w/120V Wall Transformer
4" Digital Clocks - Double Face¹	
DF-DTC400-4-24V	TimeCast 4" Double Face Digital Clock, 4-Digit, 24V
DF-DTC400-4-120V-HW	TimeCast 4" Double Face Digital Clock, 4-Digit, w/120V Hard-Wired Transformer
DF-DTC400-4-120V-WT	TimeCast 4" Double Face Digital Clock, 4-Digit, w/120V Wall Transformer
DF-DTC400-6-24V	TimeCast 4" Double Face Digital Clock, 6-Digit, 24V
DF-DTC400-6-120V-HW	TimeCast 4" Double Face Digital Clock, 6-Digit, w/120V Hard-Wired Transformer
DF-DTC400-6-120V-WT	TimeCast 4" Double Face Digital Clock, 6-Digit, w/120V Wall Transformer

Default Color is Grey. Add Suffix -BLK to part numbers for Black enclosures

1. Double Face clock assemblies include a Single Face clock and a secondary clock display for the back side of the unit.

Digital Clock Parts and Accessories

Model Number	Description
120/24V Transformers (Included in 120V Clock Assemblies)	
D2.5T-D225-BC	120/20V 2.5W Hard Wired Transformer w/ Barrel connector for Single D225
D5T-D225-BC-DBL	120/20V 5W Hard Wired Transformer w/ Barrel connector for Double D225
D5T-D400-BC	120/20V5W Hard Wired Transformer w/ Barrel connector for Single D400
D5T-D400-BC-DBL	120/20V 10W Hard Wired Transformer w/ Barrel connector for Double D400
WT-24V-BC-S	120/24VDC 0.5A Plug-in Wall Transformer, Barrel connector
Double Face Corridor Kits (Included in Double Face Clock Assemblies)	
D225-4-CORR KIT	Corridor Kit for D225, 4-Digit Clocks - Grey (add suffix -BLK for Black)
D225-6-CORR KIT	Corridor Kit for D225, 6-Digit Clocks - Grey (add suffix -BLK for Black)
D400-4-CORR KIT	Corridor Kit for D400, 4-Digit Clocks - Grey (add suffix -BLK for Black)
D400-6-CORR KIT	Corridor Kit for D400, 6-Digit Clocks - Grey (add suffix -BLK for Black)
Surface Boxes (Used for exposed conduit installations)	
D225-4-SURF BOX	Surface Box for D225, 4-Digit Clocks - Grey (add suffix -BLK for Black)
D225-6-SURF BOX	Surface Box for D225, 6-Digit Clocks - Grey (add suffix -BLK for Black)
D400-4-SURF BOX	Surface Box for D400, 4-Digit Clocks - Grey (add suffix -BLK for Black)
D400-6-SURF BOX	Surface Box for D400, 6-Digit Clocks - Grey (add suffix -BLK for Black)
D400-CORR-SURF-BOX	Corridor Kit Mounting Box for Surface Conduit Installations - Grey (-BLK)
Accessories	
CV-GUARD-S-DTC	DTC Surface Mount Clear View Protective Guard - Grey (add suffix -BLK for Black)
ADAPT-143	Adapter Plate (10x10) for mounting to NATSCO #143 Analog Clock Box-Grey
ADAPT-GENERIC	Adapter Plate (10x10) corner mounting holes
ADAPT-CUSTOM	<i>Consult Factory for custom mounting plates</i>